

# AIR BEARING SPINDLES

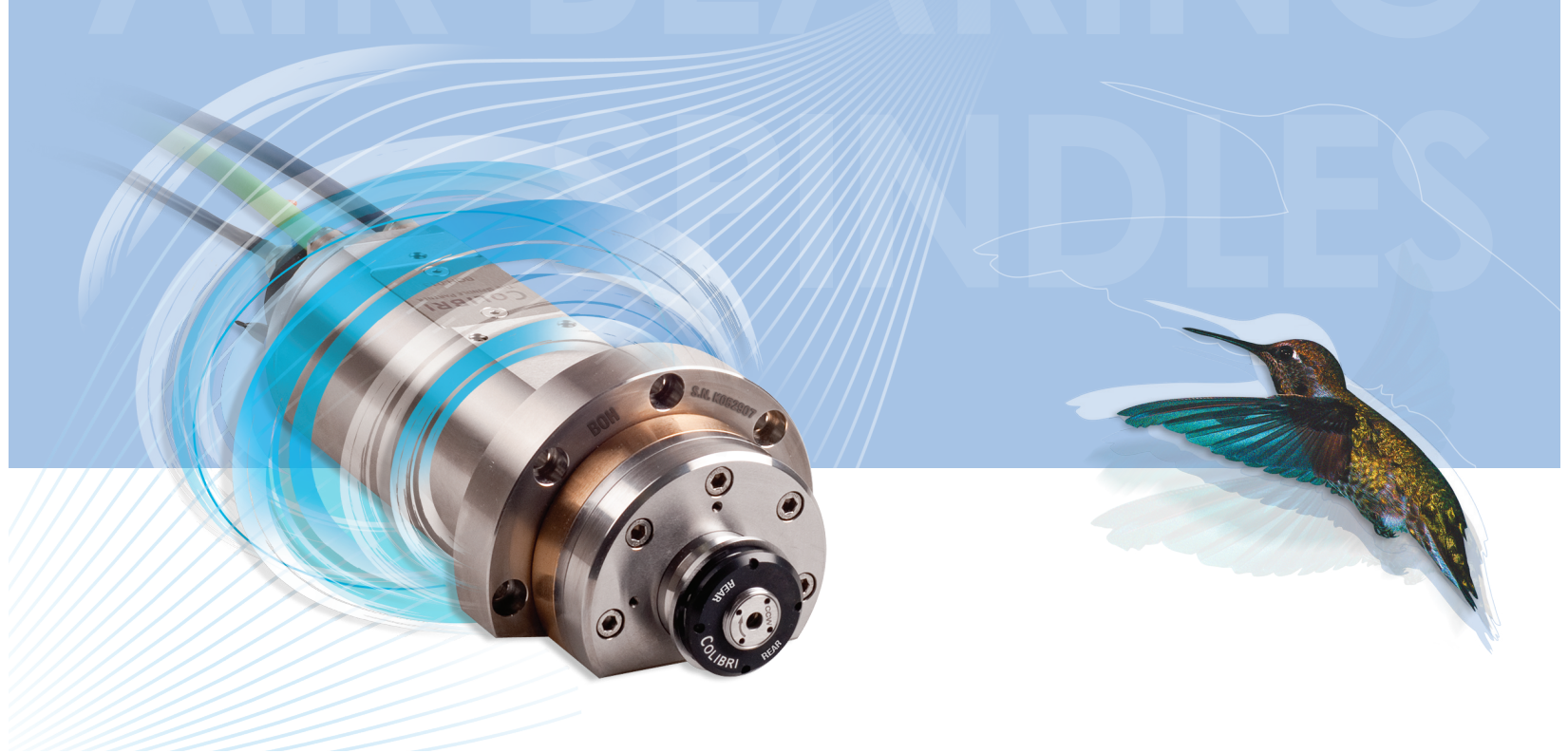

## **AIR BEARING SPINDLES** PRODUCT CATALOG & SERVICES

---

# Colibri Spindles



Colibri is a world leading company in the field of air-bearing spindles. Colibri specialized in designing and manufacturing compact air-bearing spindles, operating at high speeds, with minimal vibrations and run-out.

Colibri products are exceptional in their ability to allow designers to produce smaller, lighter, and more precise systems.

The Colibri air-bearing spindles are widely used especially in the field of semiconductor dicing and package singulation, where high rotation speed and low vibration levels are required.

The company's manufacturing facility, located at the Lavon Industrial Park in northern Israel, is where the entire process – from design to production - takes place, using the most modern and sophisticated equipment.

## Customers

Colibri serves both OEM's – machine builders, as well as end-users who use the systems for internal production.

The company's vast knowledge and expertise in the area of air-bearing design, lets it offer its customers not only ordinary spindles but also special and customized spindles and bearing solutions. Colibri provides technical customer support, assisting in process optimization, and gives consultation in the field of driving systems.

## Production

Since Colibri products perform in a demanding industry, where superb accuracy level is a must, the company uses the most advanced manufacturing equipment, capable of manufacturing parts with tight tolerances and accuracy down to a Micron.

The Colibri equipment includes advanced machine tools, measuring systems and balancing equipment.

Colibri produce all parts in-house, from rough materials through machining operations to the finest final procedures.

## R&D

Colibri designs customized air bearing spindles, providing bearing calculations using special software and analyzing tools developed in-house. The company also offers solutions for turn-key projects including sub-assemblies and specialized projects.

## Quality

Colibri is qualified for ISO standards and works under strict regulations, in order to meet the highest industry quality level and maintain customer requirements at all times.



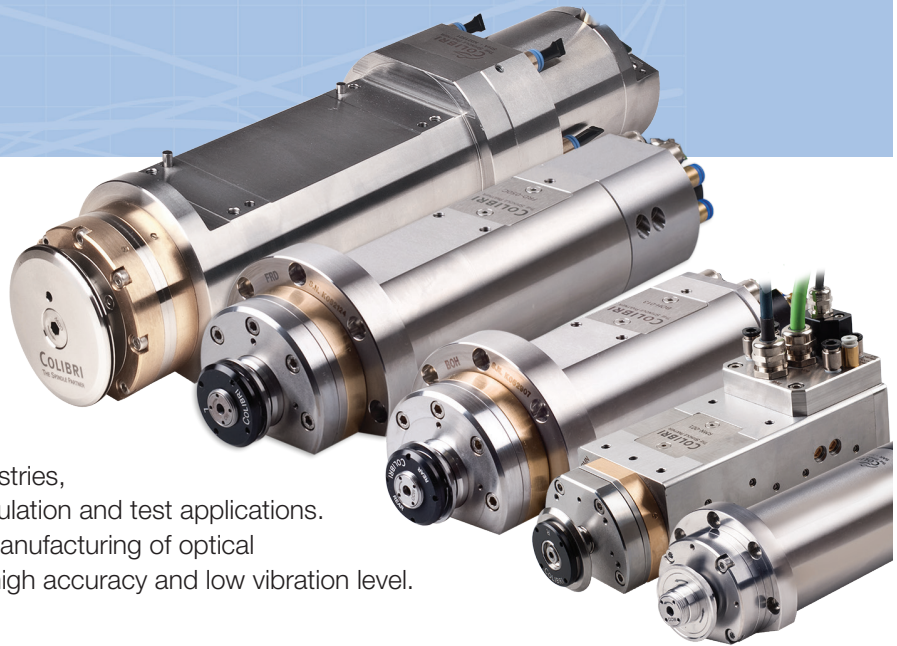

## Air-Bearing Spindles

Colibri provides spindles for the Semi-conductors industries, including: Soft and hard material Dicing, package Singulation and test applications. The Colibri air-bearing spindles are also used for the manufacturing of optical components and fine drilling applications that require high accuracy and low vibration level.

### The Spindle Package

In order to assure the best performance, Colibri offers to its customers a spindle package solution: Spindle, driver and driver accessories, blade holding systems and tools set in one combined package.

### Combined spindle solutions:

Using the advantage of the air-bearing, Colibri also provides combined spindle solutions for surface machining and micro-machining for high speed applications, where small tool size and high-rotation speed are required, especially in the metal removal industry.

Spindle model / feature	SAR	RMN	BOH	BOH-W	FRD	FRD-W	SHA-A	SHA-B
0.6kw, 45Krpm motor	✓							
1.2kw, 60Krpm motor		✓	✓	✓				
1.8kw, 60Krpm motor		✓	✓	✓				
2.4kw, 60Krpm motor					✓	✓		
2.5kw, 30Krpm motor							✓	✓
(Top mounting (Gantry		✓	✓	✓	✓	✓		✓
Combined Wheelmount		✓	✓*	✓*	✓*	✓*		
Shaft lock		✓	✓*	✓*	✓*	✓*		
ON-OFF brush system		✓						

\* Optional

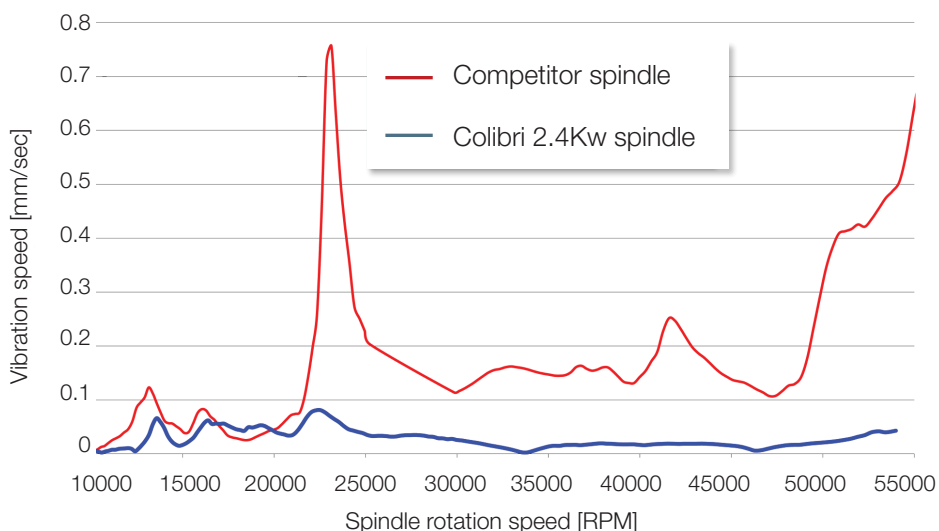



**SAR** 0.6 Kw, 45 KRPM

The SAR spindle is the smallest model of the Colibri Dicing Spindles product family. Its light weight and compact dimensions provide a great advantage for machine designers and allow for significant cost reduction and minimized machine foot-print.

The SAR spindle is suitable for thin wafer dicing, scratching and light grooving.

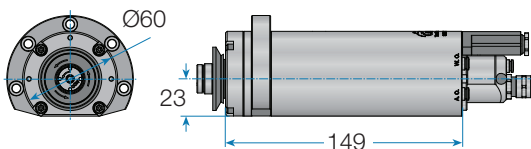

Max Speed [KRPM]	45
Motor Power [Kw]	0.6
Blade Size Supported	2"
Radial Load Capacity [N]	45
Axial Load Capacity [N]	85
Radial Stiffness [N/micron]	4
Axial Stiffness [N/micron]	8
Weight [Kg]	3

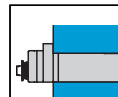

C-clamp

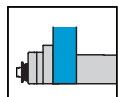

Front flange

**RMN** RMN 1.2/1.8/2.4Kw 60 KRPM

The RMN is a new and extremely shorter spindle model that was developed for compact Dicing machines. It is available in three configurations, 1.2Kw, 1.8Kw and 2.4Kw motors, all versions fit into the same spindle envelope, forming a unified robust structure with an optimized center of mass and superb dynamic behavior.

It is equipped with a new design of an air bearing system with a higher stiffness, lower air flow and a low vibration level through the operating speed range.

The spindle configuration includes an integrated shaft lock system and an ON/OFF brush system for long brush life time.

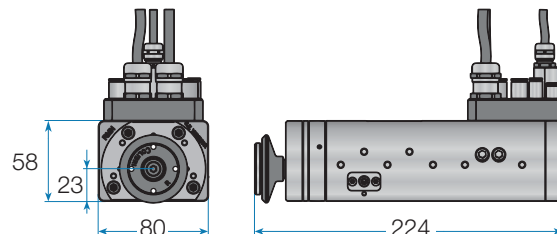

Max Speed [KRPM]	60
Motor Power [Kw]	1.2/1.8/2.4
Blade Size Supported	2", 3"
Radial Load Capacity [N]	120
Axial Load Capacity [N]	240
Radial Stiffness [N/micron]	7.5
Axial Stiffness [N/micron]	10.5
Weight [Kg]	7.3

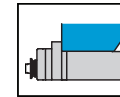

Gantry

## BOH 1.2/1.8 Kw, 60 KRPM

The BOH spindle model supports various ranges of dicing application, such as IC's, Si & GaAs wafers, ceramics, opto-electronic components, LED's, medical sensors, PZT, and the like.

This spindle was designed to deliver optimal performance at high spindle speed while maintaining exceptional stiffness and accuracy. When cut quality becomes a major process consideration, the BOH will be the most suitable spindle choice.

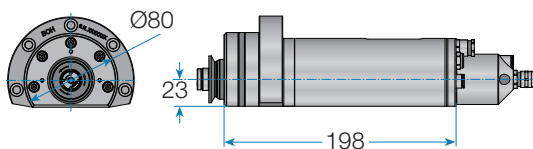

Max Speed [KRPM]	60
Motor Power [Kw]	1.2/1.8
Blade Size Supported	2", 3"
Radial Load Capacity [N]	120
Axial Load Capacity [N]	130
Radial Stiffness [N/micron]	7
Axial Stiffness [N/micron]	8
Weight [Kg]	6.5

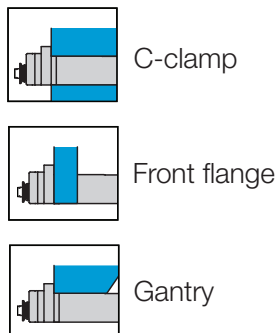

## BOH-W 1.2/1.8 Kw, 60 KRPM

The BOH-W spindle model was especially developed to support highly demanding dicing applications, where low vibration level and spindle accuracy are essential. This spindle provides an improved dynamic behavior and has been optimized to perform with extremely low vibration levels of common working spindle speed ranges.

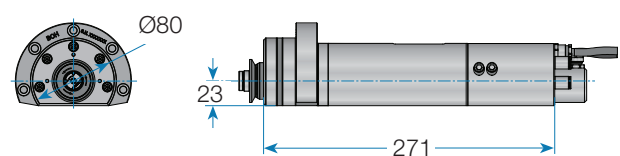

Max Speed [KRPM]	60
Motor Power [Kw]	1.2/1.8
Blade Size Supported	2", 3"
Radial Load Capacity [N]	120
Axial Load Capacity [N]	130
Radial Stiffness [N/micron]	7
Axial Stiffness [N/micron]	8
Weight [Kg]	8.4

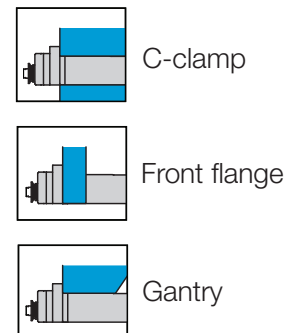



**FRD** 2.4 Kw, 60 KRPM

The FRD spindle model was designed for heavy-duty dicing and singulation applications with high throughput. The FRD model is equipped with a high power motor, providing enhanced performance and allowing to process materials at high feed rates.

The FRD spindle is the perfect spindle choice for PCB & QFN package singulation tasks. In addition, the spindle is used extensively for the dicing of semi-hard materials and thick substrates.

**FRD-W** 2.4 Kw, 60 KRPM

The FRD-W spindle model was developed to support demanding dicing and singulation applications, where low vibration level and spindle accuracy are essential.

This spindle provides an improved dynamic behavior and has been optimized to perform with extremely low vibration levels of common working spindle speed ranges.

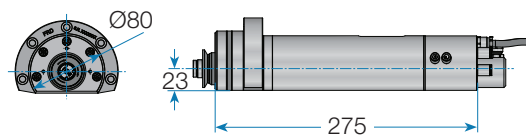
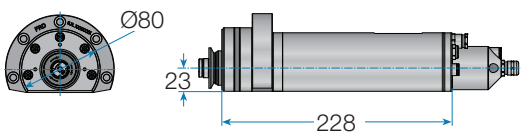

Max Speed [KRPM]	60
Motor Power [Kw]	2.4
Blade Size Supported	2",3"
Radial Load Capacity [N]	120
Axial Load Capacity [N]	130
Radial Stiffness [N/micron]	7
Axial Stiffness [N/micron]	8
Weight [Kg]	7.5

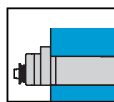

C-clamp

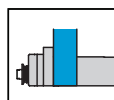

Front flange

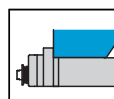

Gantry

Max Speed [KRPM]	60
Motor Power [Kw]	2.4
Blade Size Supported	2",3"
Radial Load Capacity [N]	120
Axial Load Capacity [N]	130
Radial Stiffness [N/micron]	7
Axial Stiffness [N/micron]	8
Weight [Kg]	8.5

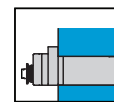

C-clamp

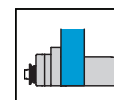

Front flange

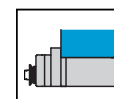

Gantry

## SHA-A 2.5 Kw, 30 KRPM

The SHA-A model is the largest spindle of the Colibri Dicing spindles product family. It was designed for heavy-duty dicing application of hard materials, such as thick ceramics, glass, sapphires, TIC and others.

Owing to its ability to support a large blade diameter, this spindle is also often used for dicing passive components.

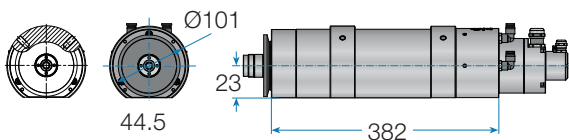

Max Speed [KRPM]	30
Motor Power [Kw]	2.5
Blade Size Supported	4"
Radial Load Capacity [N]	260
Axial Load Capacity [N]	490
Radial Stiffness [N/micron]	12
Axial Stiffness [N/micron]	26
Weight [Kg]	21

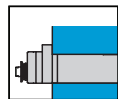

C-clamp

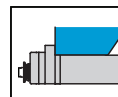

Gantry

## SHA-B 2.5 Kw, 30 KRPM

The SHA-B spindle model was developed for heavy-duty package singulation applications with extremely high throughput and large blade diameter.

The SHA-B provides significantly higher rotor stiffness and load capacity as compared with the smaller spindles in the Colibri product family, and is especially suitable for processing BGA, QFN, LTCC and similar materials at high feed rates.

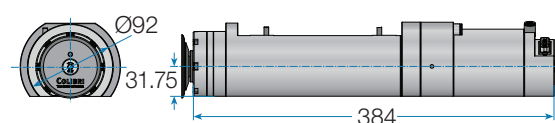
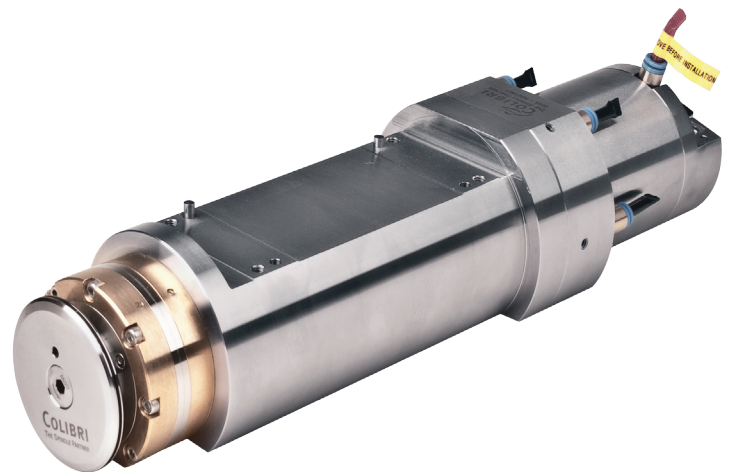

Max Speed [KRPM]	30
Motor Power [Kw]	2.5
Blade Size Supported	3", 4"
Radial Load Capacity [N]	260
Axial Load Capacity [N]	490
Radial Stiffness [N/micron]	12
Axial Stiffness [N/micron]	26
Weight [Kg]	15

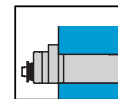

C-clamp

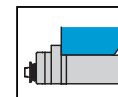

Gantry

# Products



## Drivers

### The Spindle & Driver Package

In order to assure the best performance, Colibri offers to its customers a spindle & driver package solution: Spindle, driver and driver accessories in one combined package.

The drivers are optimized to handle the spindle motors efficiently, with maximum performance.

The drivers offered are all digital and equipped with a friendly user interface.

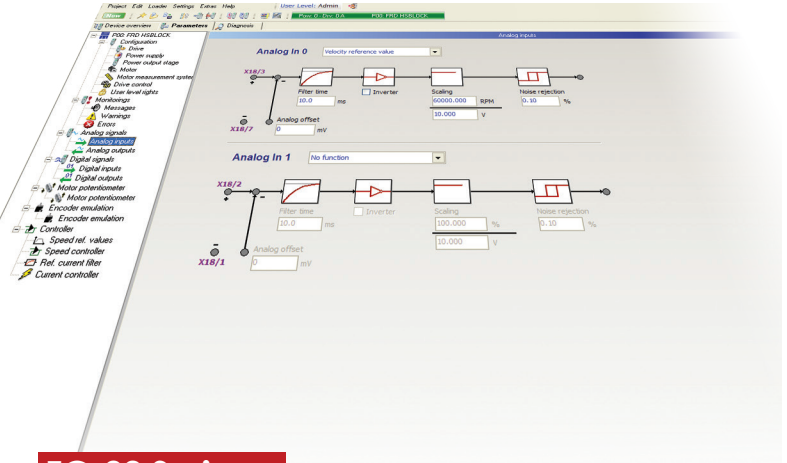

### SD2S Series

This new generation driver series combines sophisticated software and hardware, allowing operation of the spindle motor at Sensorless or Sensor modes using the same hardware platform.



### FC-80 Series

The FC-80 driver series is used widely along with Colibri spindles, and its performance and reliability have been proven in the field for many years. Colibri customers can choose between Sensorless and Sensor driving platforms





## Blade Holders and Tools

### Standard Titanium Flange Set

Standard blade holder for hubless blade for 2" and 3" blade OD.



### Combined Wheelmount Systems

Combining wheelmount and flange in one unit for 2" and 3" blade OD.



### Tools Set

Tools sets for blade exchange and wheelmount handling. A pre-set torque drive provides repeatable tightening torque.

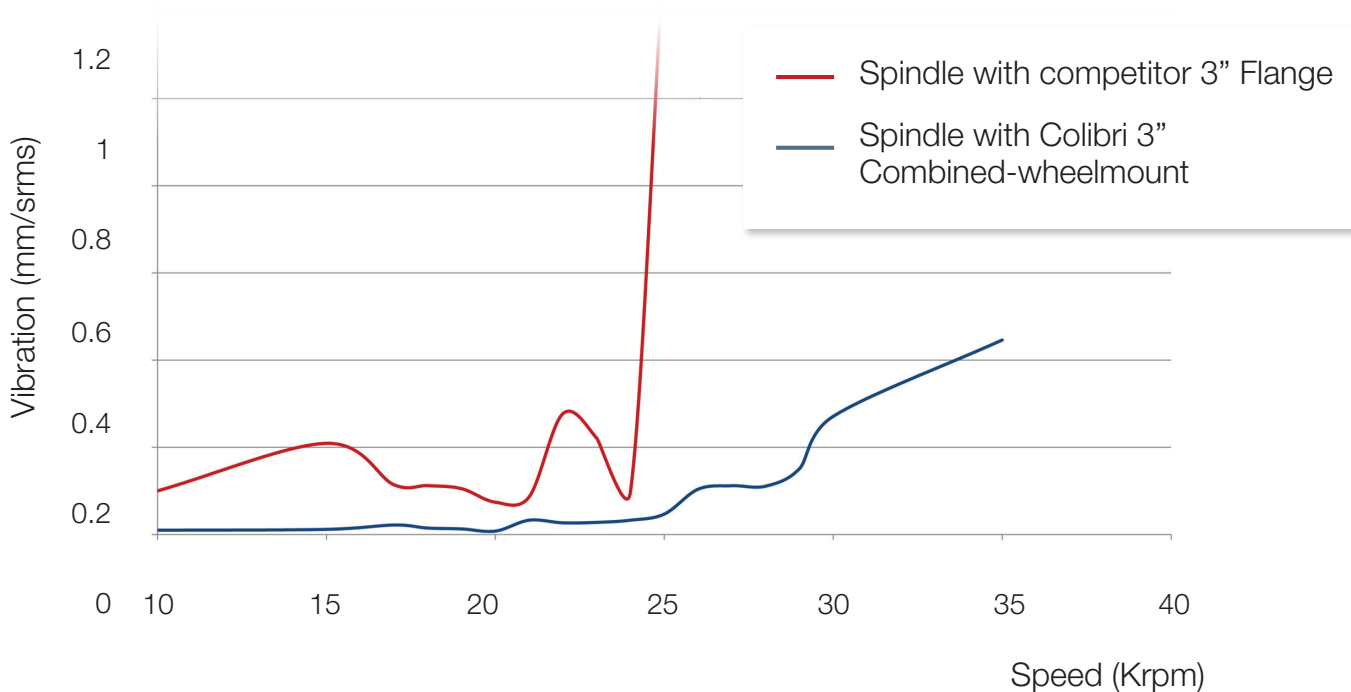

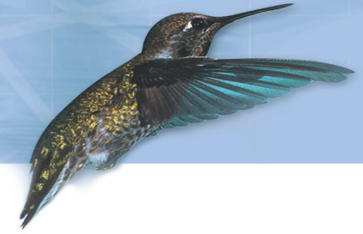

## Spindle Repair Service

As a spindle designer and manufacturer, Colibri offers to its customers, both OEM's and End-users, professional spindle repairs services. Colibri Spindle Repair shop repairs air-bearing spindles for many years and have a vast accumulated experience in repairing all types of air bearing spindle models.

### Repair Service Advantages

- Repairing all types of spindles, of various manufacturers
- Short lead-time
- Detailed repairing report
- Dynamic balancing down to G04 grade
- In-house manufacturing of replacement parts
- Professional test & inspection processes
- Extended warranty
- All in-house

## Dynamic Balancing

In addition to Colibri's specialization in manufacturing spindle rotors for high-speed operation, the company also offers sub-contracting services for dynamic balancing of rotating elements such as rotors, tool holders, turbines, etc.

Colibri is capable of producing balance rotating elements down to G04 grade.

## Engineering projects

Colibri's engineering team is made up of professionals with extensive knowledge and expertise in the field of air-bearing design. We specialize in customized and turn-key engineering projects with combined air-bearing and driving systems that manage high speeds, with great accuracy and superior balancing level.

Colibri uses sophisticated in-house developed analyzing and calculation software, to assure the achievement of desired performance from the prototype stage through to the performance approval.

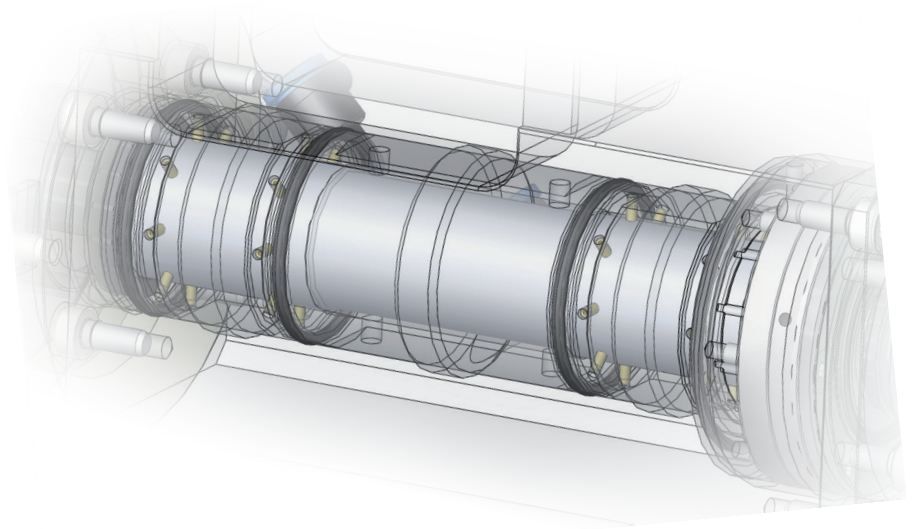

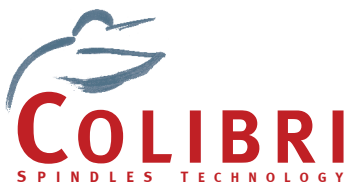

**Colibri Spindles Ltd.**

Lavon Industrial Park, 2011800, Israel  
Tel: +972-4-9089101, Fax: +972-4-9089061  
marketing@colibrispindles.com  
www.colibrispindles.com

